

# Chinese steamed dumpling Steamer User manual

## A. Chinese steamed dumpling Steamer

### Operation Manual

---

- Thank you for purchasing the Chinese steamed dumpling Steamer.
- To ensure proper operation, please read this manual carefully before using.
- After reading, keep this manual in a convenient place for further reference.

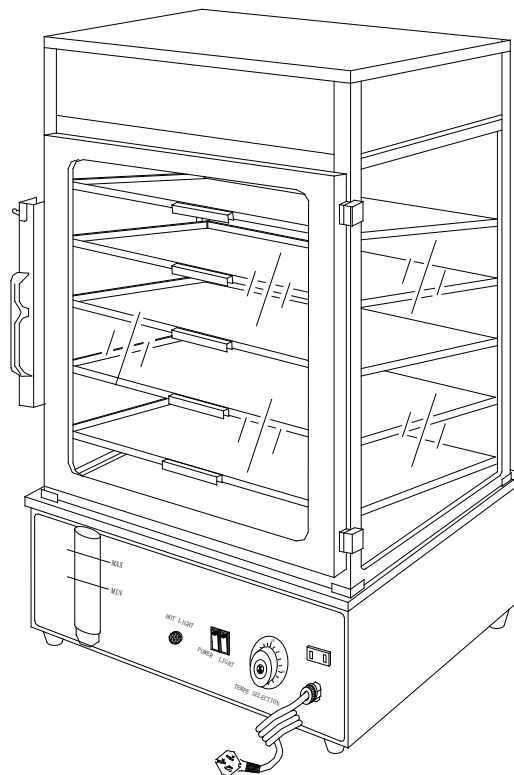

### SAVE THESE INSTRUCTIONS

Be Sure to Read this for Safety

Thoroughly read this section before you operate steamer in order to become familiar with appropriate operation and to avoid accidents.

# Contents

1. Be Sure to Comply with This for Safety.....	3
1.1 Notices on installation.....	3
1.2 Notice on operation.....	4~6
2. Safety Precautions.....	6
3. Purpose of Using the Steamer.....	7
4. Names of Parts.....	7
5. Using the Steamer.....	8
5.1 Preparatory works before using.....	8
5.2 Steaming Chinese buns.....	9~10
5.3 Supplying Chinese bun.....	10
5.4 Supplying water.....	10
6. Maintenance of Steamer.....	11
6.1 Replacing water.....	11~12
6.2 Cleaning storage.....	12~13
7. When Not in Use.....	13~15
8. Storing the Steamer.....	16

## 1. Be Sure to Comply with This for Safety

**WARNING** :Indicates that any operation not conforming to the notice following this can cause a serious accident resulting in death or serious injury.

**CAUTION** :Indicates that any operation not conforming to the notice following this can cause a slight or moderate injury, or moderate injury, or cause other products to be damage.

### 1.1 Notices on installation

#### WARNINGS

- Installing the steamer (both for the counter-top and floor types), in a location free from rain and snow.

- A wet steamer can be a source of electrical shock and the steamer can be damaged.
- Be sure to install complying with industry standards. Incomplete installation can cause stumbling accidents, electrical shock, fire or water leakage.

- The power plug must be connected to a dedicated receptacle with the Phase and Current Capacity of the requirement on the Rating Label.

Violating this standard can cause electrical shock or fire. If you cannot identify the specification of the power receptacle used, consult our local service station.

- Be sure to connect a ground wire to the steamer.

Operating the steamer without grounding it can cause electrical shock or fire by a short circuit.

- Do not extend the power cord by connecting more than one power cord, or connect the power cord to a receptacle by branching inappropriately. The

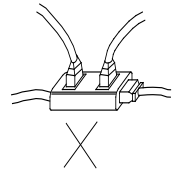

- Do not bundle the power cord; otherwise a fire can be cause. Do not step on, squeeze, or forcedly twist the power cord; otherwise the power cord can be

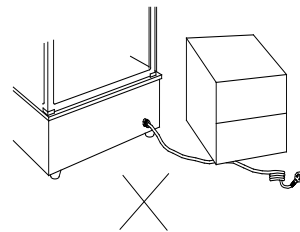

## CAUTIONS

- Do not carry the steamer by yourself. Ask for another's help. The steamer should not be carried by one person; otherwise it may be dropped and cause injury.

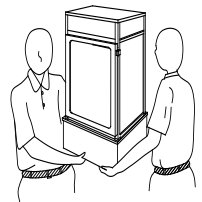

- Be sure to install the steamer on a flat and solid surface. Otherwise the unit may topple over, causing injury or burns, or water in the unit may overflow.

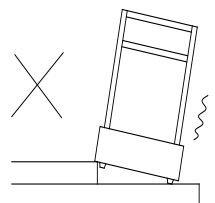

- Be sure to provide the top and sides of the steamer with clearance of at least 4 inches (10cm). Insufficient clearance may cause generated heat or

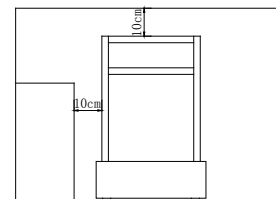

## 1.2 Notices on operation

### WARNINGS

- Do not touch the power plug with a wet hand; otherwise, you can get an
  - Do not operate any switch with a wet hand; otherwise, you can get an electrical shock. Disconnect the power cord by holding the plug part.
- Pulling the power cord can damaged it and lead to electrical shock

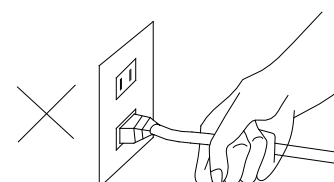
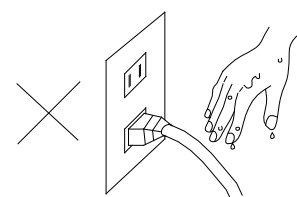

- Do not use combustibles (e.g., thinner), combustible gases, or volatile matter near the steamer; otherwise explosion or fire can be caused.
- Do not warm up carbonated drinks in cans or bottles; otherwise the containers can explode, causing injuries.
- Never store solvents or chemicals (e.g., alcohol, thinner) in the steamer; otherwise they can explode when being warmed up.

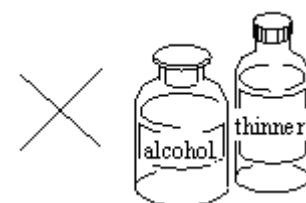

- Be careful to not spill water around the steam when filling it; otherwise electrical shock can be

caused. If you have spilled water, wipe it away immediately.

- Do not pour hot water directly; otherwise the steam can cause burns.
- When opening the door during heating or keeping the steamer hot, keep your face away from the steamer; otherwise the steam can cause burns. Before opening the door fully, open the door only by about 2 inches (5 cm) to release the steam.

When opening the door, also keep your face at least 20 inches (50cm) away from the steamer.

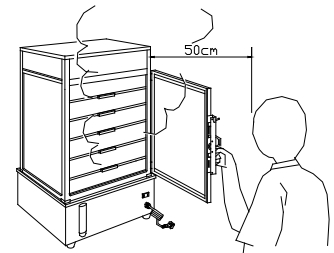

- Do not put your hand into the storage during heating or keeping the steamer hot otherwise the steam can cause burns. Be sure to use the dedicated tongs for taking steamed buns in and out.

If steam suffers burns, cool the affected part with cold water and see a doctor immediately.

- Do not touch any place except for the handle and switch during heating and keeping the steamer hot, otherwise you can suffer burns since the body is very hot.

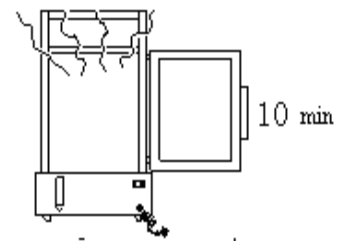

- Before draining water out, turn off the power and wait for at least 40 minutes; otherwise you can suffer burns when draining.
- Do not splash water over or wash the body of the unit; otherwise you can get electrical shock, or the body be damaged.
- Keep the electric parts in the steamer away from rainwater and cleaning water. Getting the steamer wet can cause electrical shock.

- When inspecting, cleaning, or maintaining the body, be sure to turn off the power switch and disconnect the power plug; otherwise you can get electrical shock caused by a short circuit.

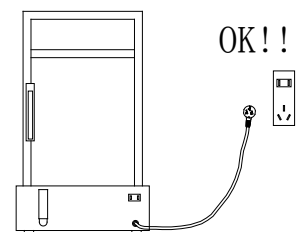

- In any of the following cases, turn off the power and disconnect the power plug from the receptacle, and consult our local service station.
  - When the functional part of the body has been flooded.
  - When the body has toppled over or is damaged.
  - When the body smokes or produces a bad odor.

Using the steamer under the above condition can cause electrical shocks or fires.

- If the steamer has been submerged due to a disaster or other problem, replace all electric parts and wiring. Otherwise, electrical shock or fire can be caused.
- Store the steamer under the conditions described in this operation manual. Storing the steamer in nonconforming conditions can cause accidents.
- Do not stack the steamer by three or more heavy; otherwise stumbling accidents or injuries can be caused.

## 2. Safety Precautions

**This section describes the notices we recommend for safe operation of the “Chinese steamer dumpling Steamer”. Be sure to read through this section before you start using the steamer and comply with the notices.**

- Do not place anything on the steamer; otherwise defects can be caused.
- Do not pour any water except for the tap water; otherwise defects can be caused.
- When cleaning the inside of the storage, do not use any detergents, such as neutral detergent or cleansers; otherwise the parts can be degraded or hot water can overflow from the steam exhaust nozzle.

**Note that overflowing hot water is not a defect. If hot water overflows, replace the water.**

- Clean the inside of the storage daily; otherwise defects or bad smell can be caused.
- Replace the water in the steamer at least three times a day (i.e., once per eight hours); otherwise defects or bad smell can be caused or hot water can overflow from the steam exhaust nozzle.

### 3. Purpose of Using the Steamer

## WARNINGS

- Do not warm up carbonated drinks in cans or bottles; Otherwise the containers can burst causing injuries.
- Never store solvents or chemicals (e.g., alcohol, thinner) in the steamer; otherwise they can explode when being warmed up.
- The steamer is designed only to be used as a steamer dedicated Chinese buns. Do not use for other purposes.

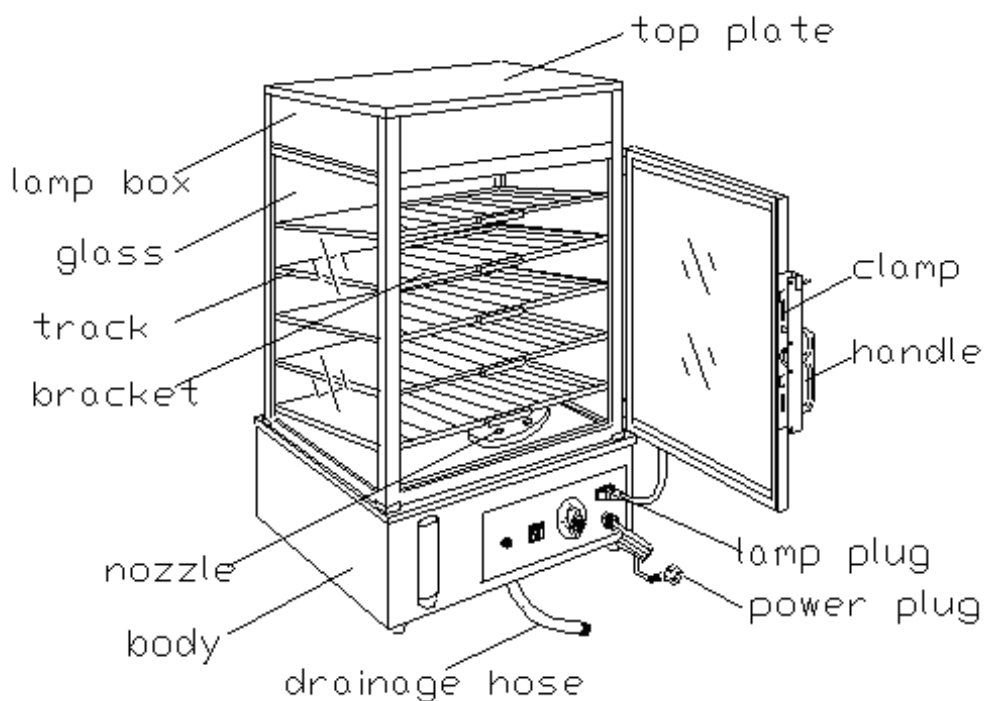



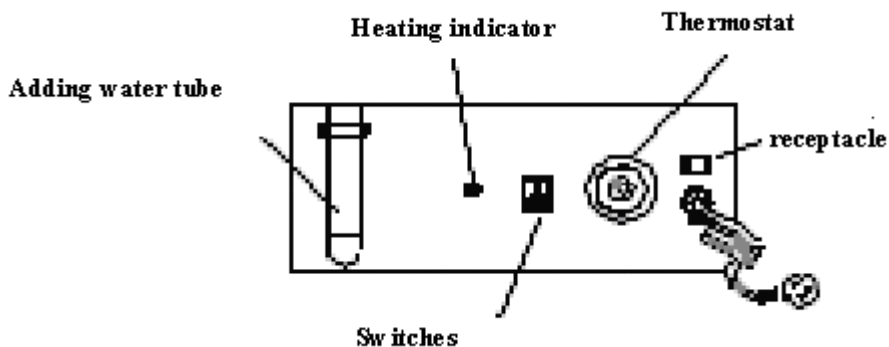

## 5. Using the Steamer

### 5.1 Preparations before using

- ① Take out the tray from the body and wash it. When cleaning the inside of the storage, do not use any detergents, such as neutral detergent or cleansers;

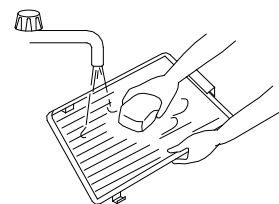

otherwise the steamers in the storage can be degraded. or hot water

- ② Wipe the inside and outside of the steamer with a damp cloth. Then, wipe with dry cloth.

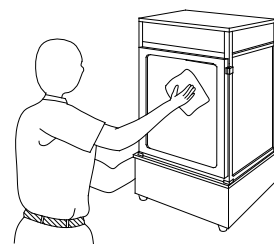

- ③ Connect the plug to the receptacle.

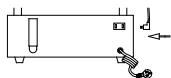

- ④ Pour tap water (approximately four liters) through the water level indicating pipe from a kettle until the specified level is reached.

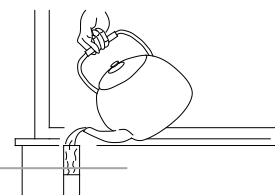

- ⑤ Connect the power plug to a dedicated socket.

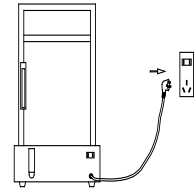

## 5.2 Steaming Chinese steamed dumpling

### WARNINGS

- **When opening during heating or keeping the steamer hot, keep your face away from the steamer; Otherwise the steam can cause you burns.**
- **Before opening the door fully, open the door only by about 2 inches (5cm) to free the steam. When opening the door, also keep your face at least 20 inches (50cm) away from the steamer.**
- **Do not put your hand into the storage during heating or when the steamer is hot; Otherwise the steam can cause burns. Be sure to use the dedicated tongs for taking steamed buns in and out.**

- ① Turn on the power switch of the steamer.

- **The power switch indicator and water level lamp lights up.**
- **Make sure that the door of the steamer is closed.**

- ② Put Chinese buns on a clean tray.

(One tray can accommodate up to nine Chinese buns.)

- **Make sure that the top of the tray is face up.**
- **When arranging Chinese steamed dumpling, do not stack them or have them stick beyond of the edges of the tray.**

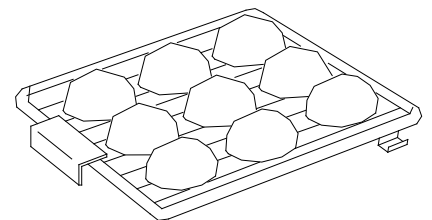

- ③ Put the tray of Chinese buns into the storage when the thermometer indicates 158°F(70°C).

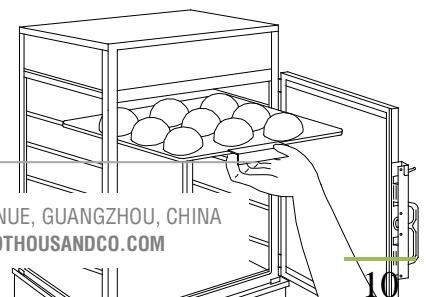

**158°F(70°C) will be reached approximately 20 to 30 minutes**

**after turning on the power. Insert the claws of the tray into the rails securely.**

- ④ When the temperature reach the setting time, the heating indicator is not on, and the temperature will in a constant temperature.

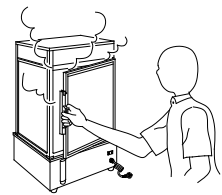

- ⑤ Take out the Chinese buns steamed up.

- **Before opening the door fully, open the door only by about 2 inches (5cm) to free the steam.**
- **Take out the tray using the dedicated tongs by 2/3 of the tray length, and take out the Chinese buns as required.**

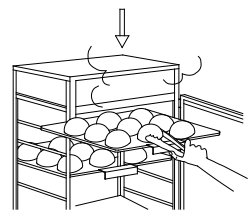

### 5.3 Supplying Chinese steamed dumplings

- ① Use cloth or a towel take out the tray from the body.
- ② Wash the tray in water.
- ③ Put Chinese buns on the washed tray. (One tray can accommodate up to nine Chinese buns.)
- Make sure that the top of the tray is facing upward.
  - When arranging Chinese buns, do not stack them or have them stick beyond of the edges of the tray.
  - Place the tray of new Chinese buns on the upper level in the steamer.
  - When taking out the stored Chinese steamed dumpling, first take out the older Chinese steamed dumpling.

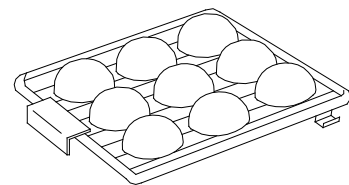
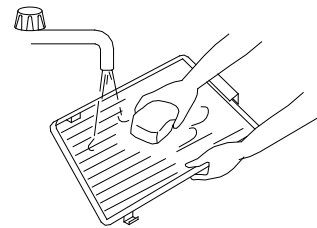

### 5.4 Supplying water

- ① When the level shown by the water level indicator reaches the “Requiring water supply” or water level lamp goes off, pour additional water through the water level indicator inlet from a kettle until the

“Appropriate water level” is reached.

- **If the water in the steamer runs out of the water, the water level lamp automatically goes off.**
- **After pouring water, depress the additional burning switch. (When the temperature in the storage reaches 185 °F (85 °C ), the additional burning switch is automatically turned off and the steamer maintains the specified temperature.)**

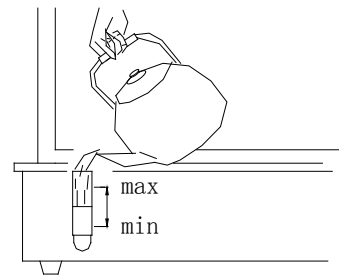

## 6. Maintenance of steamer

### 6.1 Replacing water

Replace the water in the steamer every eight hours, since the fat from the Chinese buns can get mixed with the steam and enter the tank of the steamer, thus contaminating the water in it. Prepare a plastic bucket (with capacity of 4 liters or more)

# WARNINGS

- When inspecting, cleaning, or maintaining the body, be sure to turn off the power switch and disconnect the power plug; Otherwise you can get electrical

① Turn off the power switch and disconnect the power plug from the receptacle.

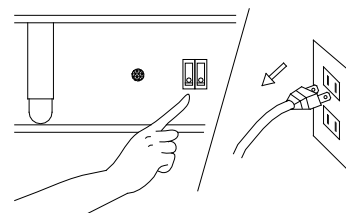

② Point the drainage hose upward and bend it at about 4 inches away from its end.

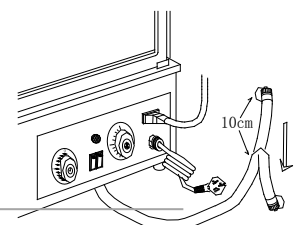

- ③ Take off the drainage cap.

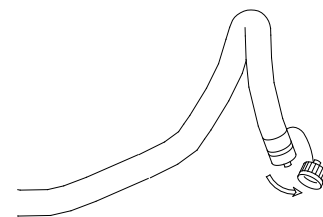

- ④ Hold the drainage hose to keep it bent and put it in the plastic bucket.

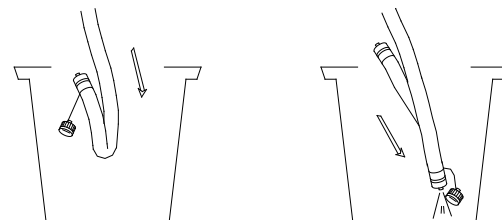

- ⑤ Release the hose to let the water being drained.  
⑥ When all hot water has been drained, re-secure the drainage cap.



- ⑦ Pour tap water( approximately four liters) through the water level indicating pipe from a kettle until the specified level is reached.

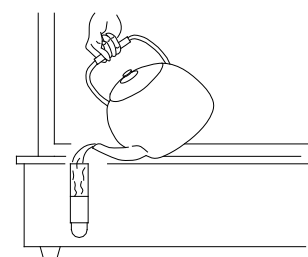

- ⑧ Connect the power plug to the receptacle and turn on the power switch.

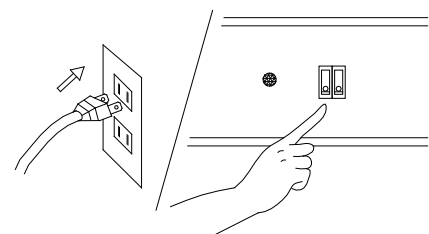

## 6.2 Cleaning storage

Clean the inside of the storage daily to keep the storage clean.

### WARNINGS

- When inspecting, cleaning, or maintaining the body, be sure to turn off the



NO.18 - 105, HUAGANG GARDEN, ZHONGSHAN AVENUE, GUANGZHOU, CHINA  
T: 86-20-38768241 | F: 86-20-38769376 | [WWW.TWOTHOUSANDCO.COM](http://WWW.TWOTHOUSANDCO.COM)

electrical shock caused by a short circuit.

- To maintain the inside of the steamer, open the door and leave it for at

- ① Turn off the power switch and disconnect the power plug from the receptacle.

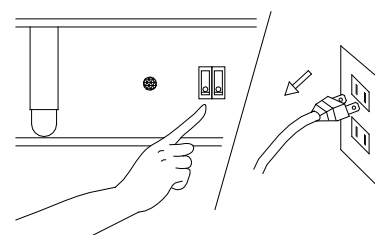

- ② Open the door and take out all trays using the dedicated tongs.

**Use a cloth such as a dish towel or the like to take out the trays.**

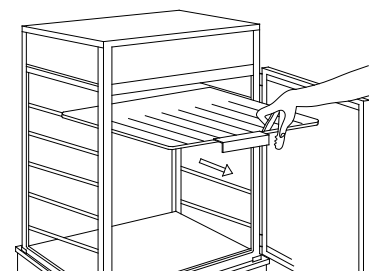

- ③ Open the door and leave it for at least 10 minutes to lower the temperature in the storage.

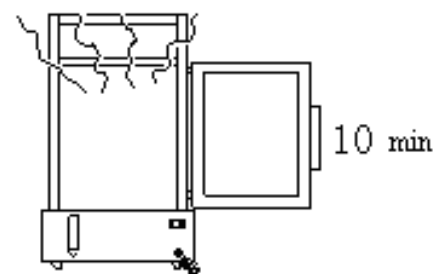

- ④ Wipe the storage using a damp cloth.

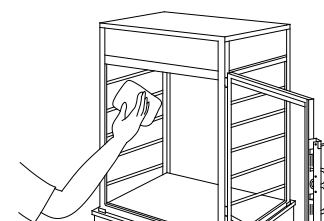

- ⑤ Return all the trays that had been removed from the storage.

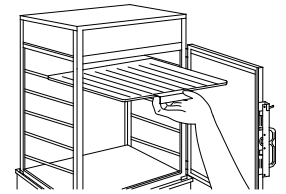

## 7. When Not Use

To stop the steamer operation, follow the procedure below.

### WARNINGS

- When inspecting, cleaning, or maintaining the body, be sure to turn off the power switch and disconnect the power plug; Otherwise you can get electrical shock caused by a short circuit.
- To maintain the inside of the steamer, open the door and leave it for at least 10 minutes; Otherwise the steam can cause burns.
- Do not touch the power plug with a wet hand; otherwise you can get electrical shock.
- **When removing dirt on the steamer, do not use chemicals, such as thinner or benzene; Otherwise accidents can be caused.**

- ① Turn off the power and disconnect the power plug from the receptacle.

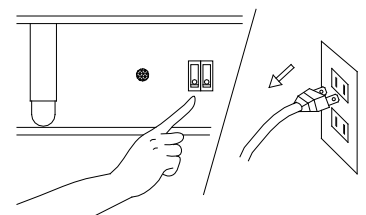

- ② Open the door and take out all trays using the dedicated tongs.

Use a cloth such as a dish towel to take out the trays.

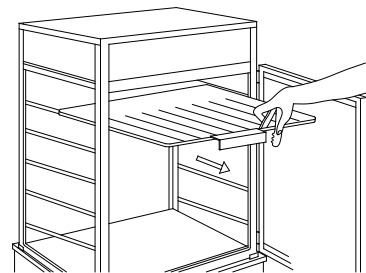

- ③ Open the door and leave it for at least 10 minutes to lower the temperature in the storage.

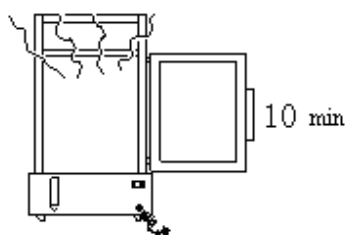

- ④ Point the drainage hose upward and bend it at about 4 inches (100mm) away from its end.

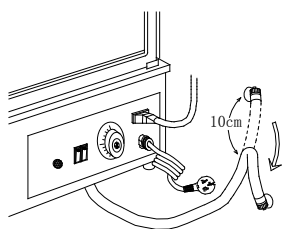

- ⑤ Take off the drainage cap.



⑥ Hold the drainage hose to keep it bent and put it in the plastic bucket.

⑦ Release the hose to let the water drained.

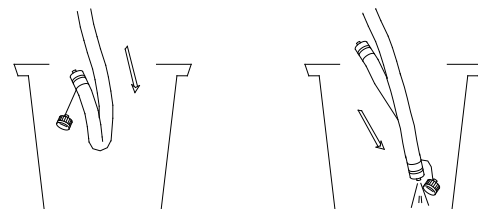

⑧ When all hot water has been drained, re-secure the drainage cap.

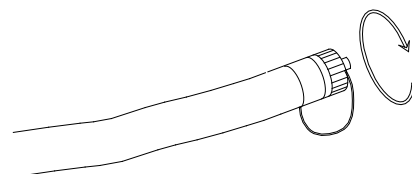

⑨ Wipe the storage using a damp cloth.

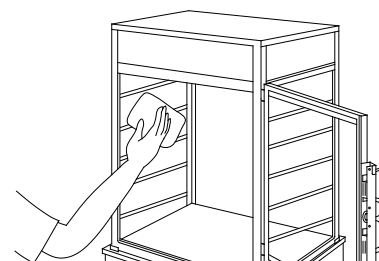

⑩ Take off the Chinese steamed dumpling, if any, then wash the tray and wipe it with a dry cloth.

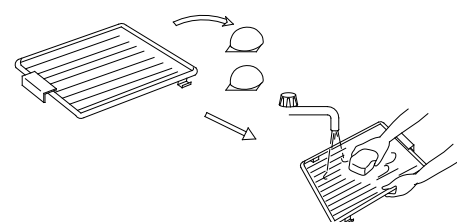

⑪ Return the tray to the storage.

## 8. Storing the Steamer

- ① Follow the procedure of Section 7. "When Not In Use".
- ② Bundle up the power cord and put the bundle on the body.

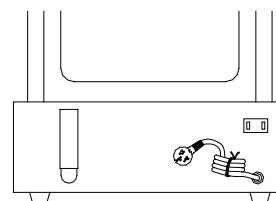

- ③ Leave the door of the steamer open for one day to let the storage dry completely. !

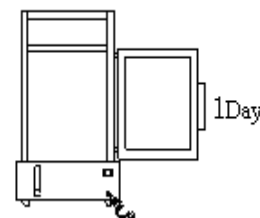

- ④ Cover the body with a plastic bag and pack it in a corrugated cardboard box.

Store it in a location with low humidity.

